



B o w d e n s & W i r i n g s d i v i s i o n

CATALOGO 2012

Sistemi dinamici di bloccaggio per mensole a sospensione

2012 CATALOGUE

Dynamic cable grippers for suspended brackets

Sistemi dinamici di bloccaggio

Dynamic locking systems

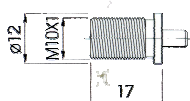
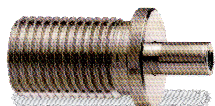

24118001

Ø 12 x 17 mm.

Fune consigliata
Recommended rope
Ø 1 - 1,6

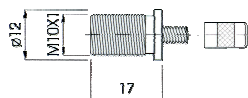
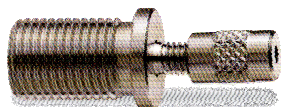

24118002

Ø 12 x 17 mm.

Con sicura
With safety case

Fune consigliata
Recommended rope
Ø 1 - 1,6

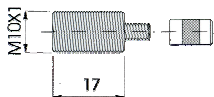
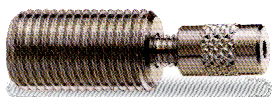

24118003

Ø 10 x 17 mm.

Con sicura
With safety case

Fune consigliata
Recommended rope
Ø 1 - 1,6

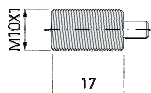
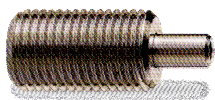

24118004

Ø 10 x 17 mm.

Fune consigliata
Recommended rope
Ø 1 - 1,6

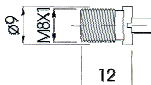
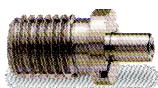

24118005

Ø 9 x 12 mm.

Fune consigliata
Recommended rope
Ø 1

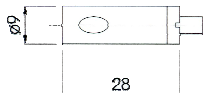
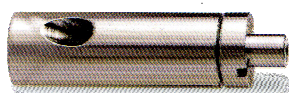

24118006

Ø 9 x 18 mm.

Fune consigliata
Recommended rope
Ø 1 - 1,2

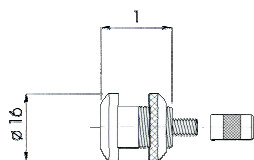
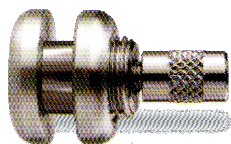

24118007

Ø 16 x 17 mm.

Con sicura - With safety case
Suspensione per mensola Suspension for bracket

Fune consigliata
Recommended rope
Ø 1 - 1,6

Sistemi dinamici di bloccaggio

Dynamic locking systems

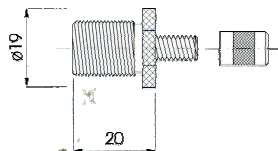
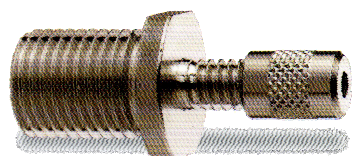

24118008

Ø 19 x 20 mm.
Con sicura
With safety case

Fune consigliata
Recommended rope
Ø 1,6 - 2,5

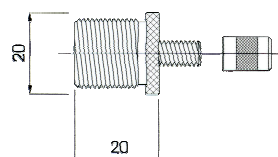
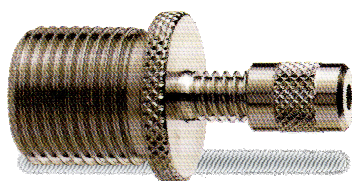

24118009

Ø 20 x 20 mm.
Con sicura
With safety case

Fune consigliata
Recommended rope
Ø 1,6 - 2,5

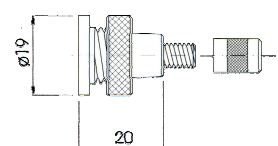
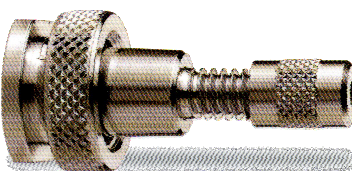

24118010

Ø 19 x 20 mm.
Con sicura
With safety case

Fune consigliata
Recommended rope
Ø 1,6 - 2,5

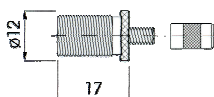
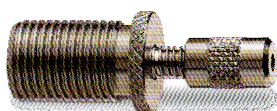

24118011

Ø 19 x 20 mm.
Con sicura - With safety case
Bloccacavo zigrinato Knurled cable gripper

Fune consigliata
Recommended rope
Ø 1,2 - 1,6

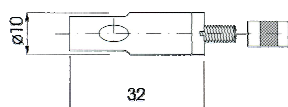
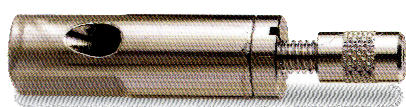

24118012

Ø 10 x 32 mm.
Con sicura
With safety case

Fune consigliata
Recommended rope
Ø 1 - 1,2

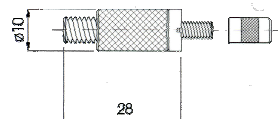
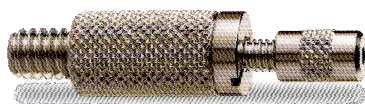

24118013

Ø 10 x 28 mm.
Con sicura - With safety case
Bloccacavo zigrinato Knurled cable gripper

Fune consigliata
Recommended rope
Ø 1 - 1,2

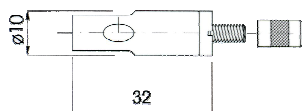
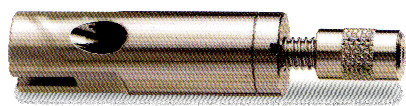

24118014

Ø 10 x 32 mm.
Con sicura + T.C.
With safety case + T.C.

Fune consigliata
Recommended rope
Ø 1 - 1,2

Accessori

Accessories

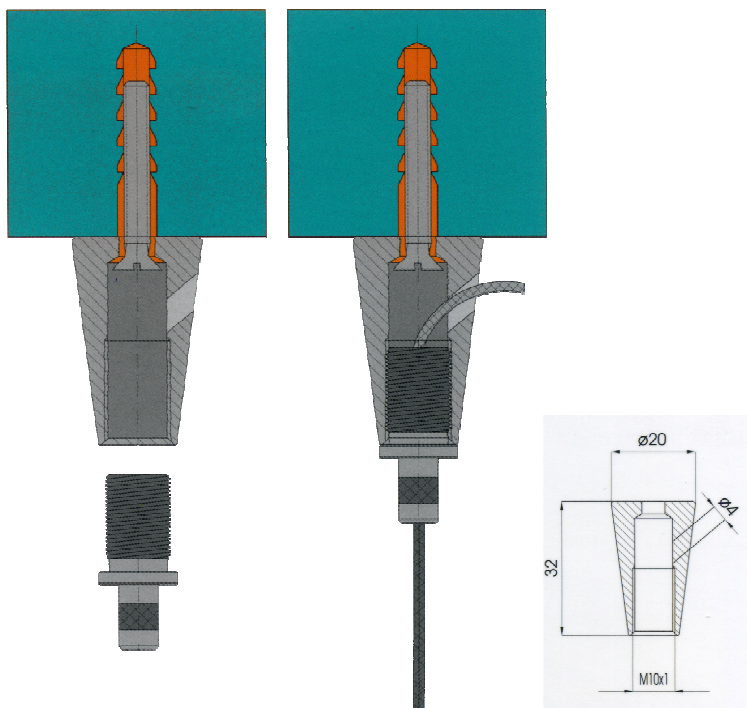

24118015

Aggancio per tassello a soffitto
Ceiling anchor accessory

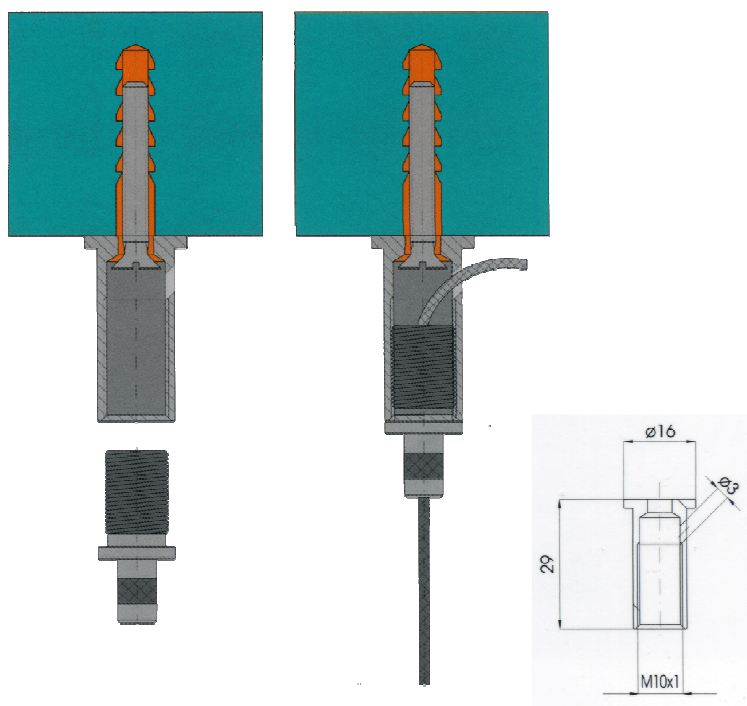

24118016

Aggancio per tassello a soffitto
Ceiling anchor accessory

Morsetto dinamico a soffitto

Dynamic ceiling cable gripper

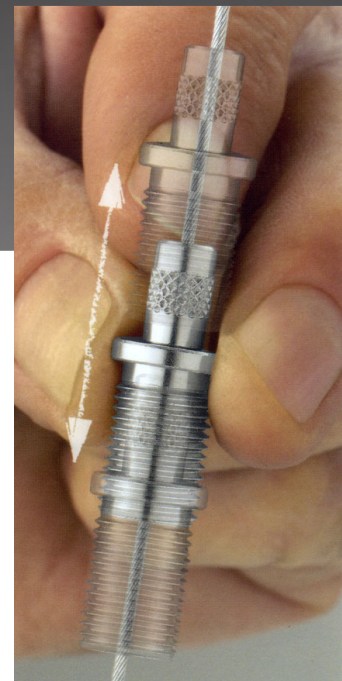

ORIGINALBERTI offre vari sistemi di bloccaggio per funi agganciate a binari, mensole e sospensioni in genere, ideali per arredamenti moderni di negozi ed uffici. Questi sistemi sono da considerarsi estremamente facili e versatili da utilizzare, poiché consentono di cambiare con rapidità la lunghezza delle funi applicate al soffitto.

ORIGINALBERTI offers a lot of systems for ceiling mounts. These systems are very easy to use, because they allow to change the wire rope length with much simplicity.

Con un semplice gesto è possibile variare la posizione del morsetto sulla fune.

Wire rope positions can be changed with a few gestures.

Morsetto dinamico a mensola

Dynamic bracket cable gripper

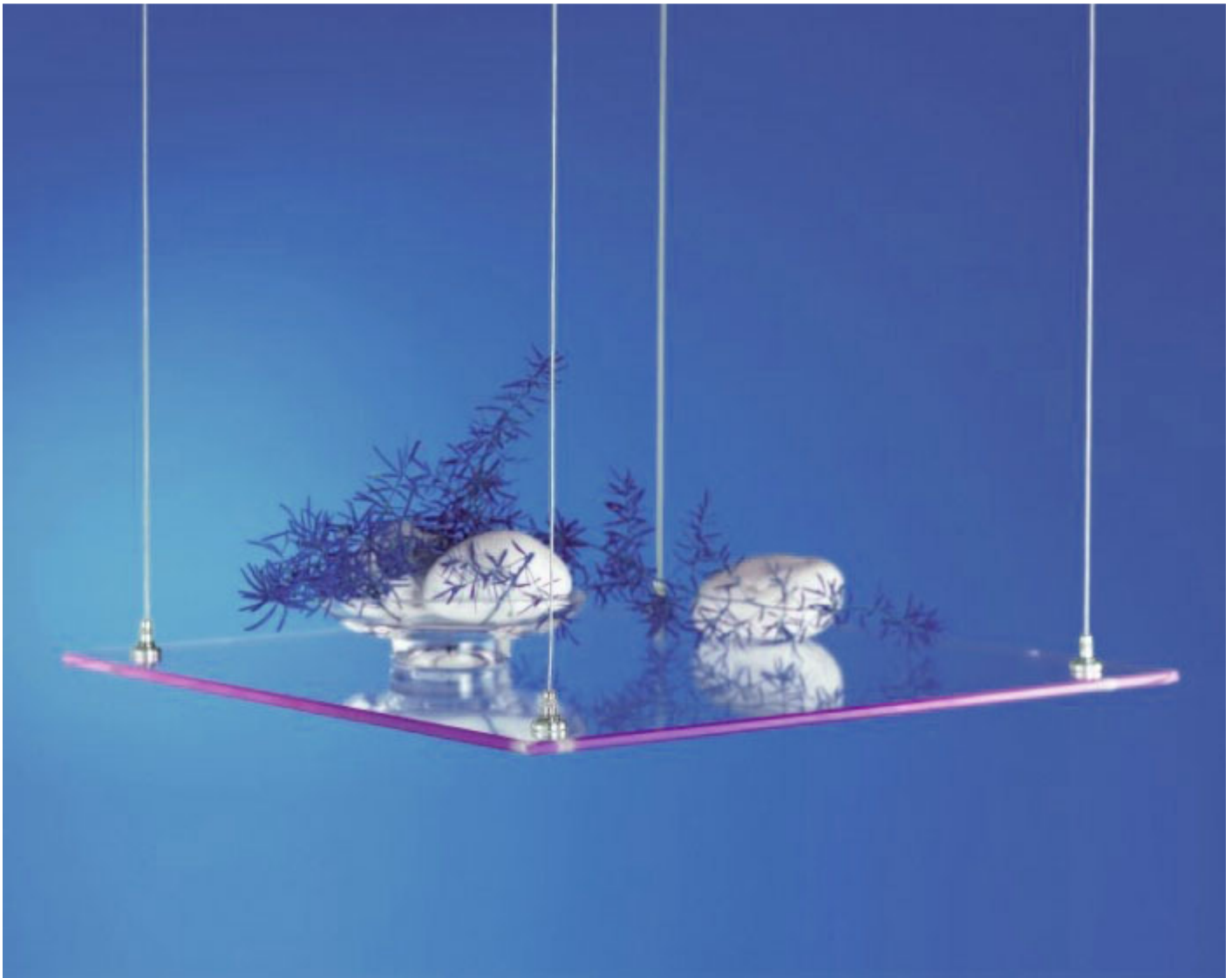

Grazie all'estrema facilità, i sistemi per mensole **ORIGINALBERTI** possono essere regolati rapidamente senza l'ausilio di attrezzi.

ORIGINALBERTI's brackets suspension systems can be used without any kind of tool.

I sistemi di sospensione per mensole **ORIGINALBERTI** sono progettati per la massima rapidità d'uso, consentendo una rapida e semplice variazione della distanza fra due mensole.

ORIGINALBERTI's brackets suspension systems are engineered for an extreme ease of use, for a faster brackets distance changes.



Visitate il nostro sito internet
www.ORIGINALBERTI.it per ulteriori
informazioni,

Please visit our website www.ORIGINALBERTI.it
for more informations.



Bowdens&Wirings division

Via Cava di Sopra, 53 – 24030 – Caprino Bergamasco (BG) – Italy
Phone: 0039 035 783038 – Fax: 0039 035 783376 – info@originalberti.it

www.originalberti.it

